

ST 050 305 2979



Fits: IMO, LULU, TARA, LISSÉ, VAIA, META, CYO

- shower with fixed riser projection 453mm
- Rain shower: PURE RAIN, max. flow rate 7 l/min (at 3 bar)
- rain shower Ø 220 mm
- rain shower with anti-scale system
- Hand shower: COMPACT RAIN, max. flow rate 15 l/min (at 3 bar)
- spray head Ø 100mm
- rotary diverter with volume control and shut-off function
- slide-on rosettes Ø 70 mm
- height of fittings up to rain shower (bottom edge) 1009mm
- height of fittings up to top edge of elbow 1150mm
- gauge 150 mm - 13 mm
- metal shower hose 1750mm with integrated anti-twist protection
- 1/2" connection
- slide bar
- Pipe diameter 23.5 mm

|  |                                |                    |
|--|--------------------------------|--------------------|
|  | Chrome                         | ST 050 305 2979-00 |
|  | Brushed Platinum               | ST 050 305 2979-06 |
|  | Platinum                       | ST 050 305 2979-08 |
|  | Dark Chrome                    | ST 050 305 2979-19 |
|  | Brushed Durabronze (23kt Gold) | ST 050 305 2979-28 |
|  | Matte Black                    | ST 050 305 2979-33 |
|  | Brushed Champagne (22kt Gold)  | ST 050 305 2979-46 |
|  | Champagne (22kt Gold)          | ST 050 305 2979-47 |
|  | Brushed Dark Platinum          | ST 050 305 2979-99 |

**Individual components of this set**

You need the following components for this set



1x 28 015 979-00



1x 34 459 979-00





























ST 050 305 2979



- COMPACT RAIN, max. flow rate 15 l/min (at 3 bar)
- with anti-scale system
- spray head Ø 100mm
- 1/2" connection

Intrinsic protection against back flow.

Fits: IMO, LULU, MADISON, MEM, TARA,  
CL.1, LISSÉ, VAIA, META, CYO

|  |                                     |                    |
|--|-------------------------------------|--------------------|
|    | Chrome                              | 28 015 979-00      |
|    | Chrome                              | 28 015 979-00 0010 |
|    | Brushed Platinum                    | 28 015 979-06      |
|    | Brushed Platinum                    | 28 015 979-06 0010 |
|    | Platinum                            | 28 015 979-08      |
|    | Platinum                            | 28 015 979-08 0010 |
|    | Dark Chrome                         | 28 015 979-19      |
|    | Dark Chrome                         | 28 015 979-19 0010 |
|    | Light Gold                          | 28 015 979-26      |
|    | Light Gold                          | 28 015 979-26 0010 |
|    | Brushed Light Gold                  | 28 015 979-27 0010 |
|  | Brushed Light Gold                  | 28 015 979-27      |
|  | Brushed Durabronze<br>(23kt Gold)   | 28 015 979-28      |
|  | Brushed Durabronze<br>(23kt Gold)   | 28 015 979-28 0010 |
|  | Matte Black                         | 28 015 979-33      |
|  | Matte Black                         | 28 015 979-33 0010 |
|  | Brushed Bronze                      | 28 015 979-42      |
|  | Brushed Bronze                      | 28 015 979-42 0010 |
|  | Brushed<br>Champagne (22kt<br>Gold) | 28 015 979-46      |
|  | Brushed<br>Champagne (22kt<br>Gold) | 28 015 979-46 0010 |
|  | Champagne (22kt<br>Gold)            | 28 015 979-47      |
|  | Champagne (22kt<br>Gold)            | 28 015 979-47 0010 |
|  | Brushed Chrome                      | 28 015 979-93      |
|  | Brushed Chrome                      | 28 015 979-93 0010 |
|  | Brushed Dark<br>Platinum            | 28 015 979-99      |
|  | Brushed Dark<br>Platinum            | 28 015 979-99 0010 |





ST 050 305 2979

mm [inches]

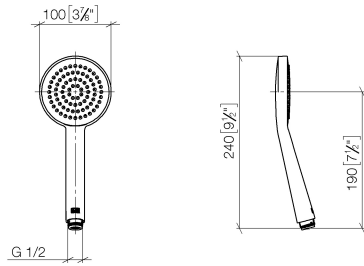

**Flow rate chart**

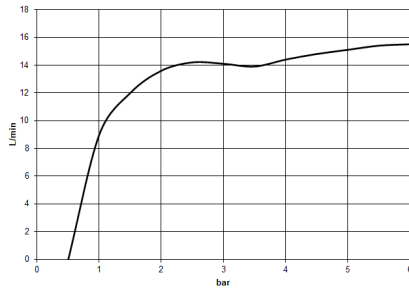

**Certificates**

DVGW\_DW-6517DN0129.      WRAS\_2009011.      LGA\_29981.

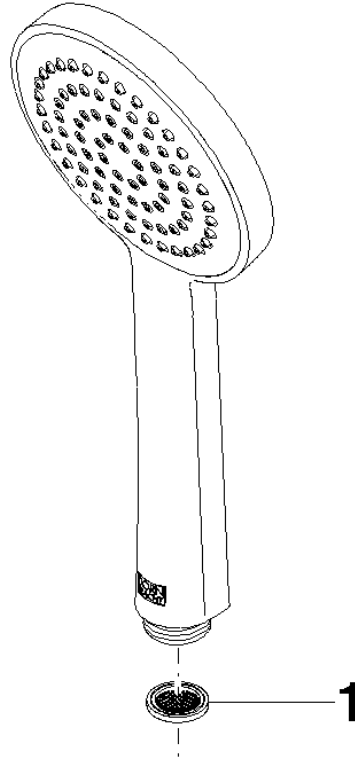

Spare parts list

| No. | Item Number     | Name  | Quantity used | Delivery time |
|-----|-----------------|-------|---------------|---------------|
| 1   | 09 23 01 039 90 | sieve | 1             | 2             |

ST 050 305 2979



Fits: IMO, LULU, TARA, LISSÉ, VAIA, META

- shower with fixed riser projection 453mm
- overhead shower: rain flow
- rain shower Ø 220 mm
- rain shower with anti-scale system
- max. rainshower flow 7 l/min
- rotary diverter with volume control and shut-off function
- slide-on rosettes Ø 70 mm
- height of fittings up to rain shower (bottom edge) 1009mm
- height of fittings up to top edge of elbow 1150mm
- gauge 150 mm - 13 mm
- metal shower hose 1750mm with integrated anti-twist protection
- 1/2" connection
- slide bar
- Pipe diameter 23.5 mm
- quick clearing
- This product can help a building meet the requirements of Green Building Rating Systems, e.g. LEED®, BREEAM®, DGNB

This article does not include a hand shower!  
Intrinsic protection against back flow.

|  |                                |               |
|--|--------------------------------|---------------|
|  | Chrome                         | 34 459 979-00 |
|  | Brushed Platinum               | 34 459 979-06 |
|  | Platinum                       | 34 459 979-08 |
|  | Dark Chrome                    | 34 459 979-19 |
|  | Light Gold                     | 34 459 979-26 |
|  | Brushed Light Gold             | 34 459 979-27 |
|  | Brushed Durabronze (23kt Gold) | 34 459 979-28 |
|  | Matte Black                    | 34 459 979-33 |
|  | Brushed Bronze                 | 34 459 979-42 |
|  | Brushed Champagne (22kt Gold)  | 34 459 979-46 |
|  | Champagne (22kt Gold)          | 34 459 979-47 |
|  | Brushed Chrome                 | 34 459 979-93 |
|  | Brushed Dark Platinum          | 34 459 979-99 |

**Required miscellaneous**

|  |  |                       |
|--|--|-----------------------|
|  | <b>Hand shower FlowReduce - Chrome</b> | 28 016 979-00<br>0010 |
|--|--|-----------------------|

**Required miscellaneous**

|  |  |                       |
|--|--|-----------------------|
|  | <b>Hand shower FlowReduce - Chrome</b> | 28 012 979-00<br>0010 |
|--|--|-----------------------|

**Required miscellaneous**

|  |                             |               |
|--|-----------------------------|---------------|
|  | <b>Hand shower - Chrome</b> | 28 017 979-00 |
|--|-----------------------------|---------------|

**Required miscellaneous**

|  |                             |               |
|--|-----------------------------|---------------|
|  | <b>Hand shower - Chrome</b> | 28 016 979-00 |
|--|-----------------------------|---------------|

**Required miscellaneous**

|  |                             |               |
|--|-----------------------------|---------------|
|  | <b>Hand shower - Chrome</b> | 28 012 979-00 |
|--|-----------------------------|---------------|

**Required miscellaneous**

|  |                             |               |
|--|-----------------------------|---------------|
|  | <b>Hand shower - Chrome</b> | 28 018 979-00 |
|--|-----------------------------|---------------|

**Required miscellaneous**

|  |  |                       |
|--|--|-----------------------|
|  | <b>Hand shower FlowReduce - Chrome</b> | 28 018 979-00<br>0010 |
|--|--|-----------------------|





## Showerpipe with shower thermostat - Chrome

---

IMO

ST 050 305 2979

ST 050 305 2979

mm [inches]  
1:10

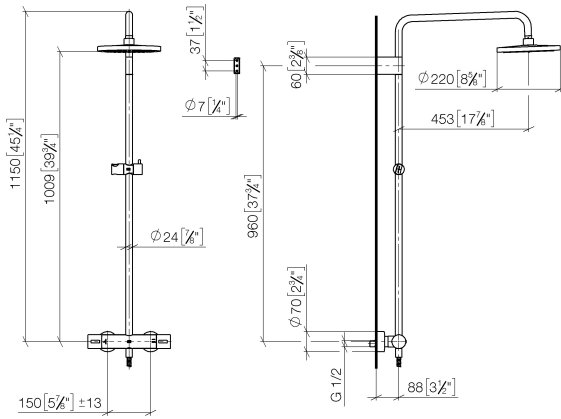

Flow rate chart

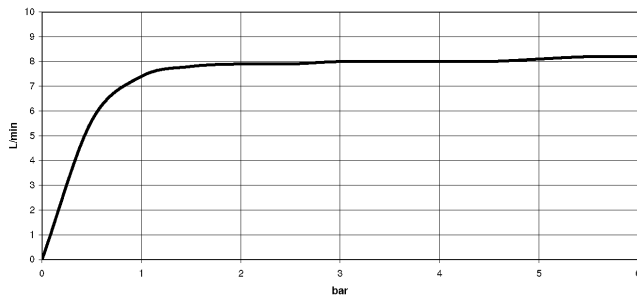

Certificates

DVGW\_DW-  
6509DN0123.

Belgaqua\_21-032-  
27\_5.

WRAS\_2204013.

LGA\_38737.

ST 050 305 2979

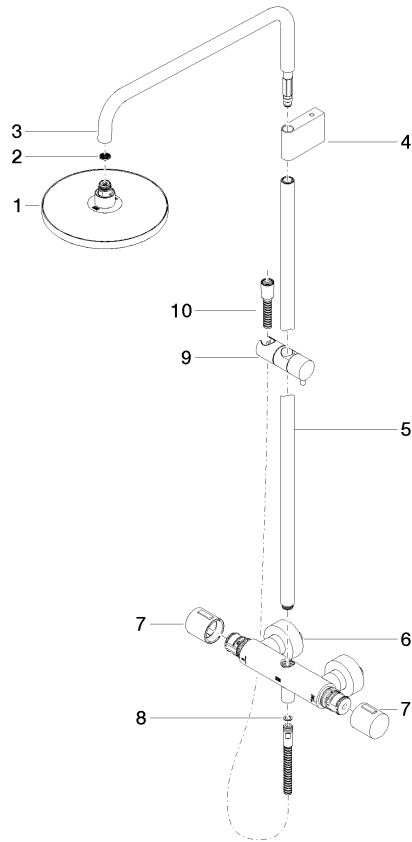

Spare parts list

| No. | Item Number        | Name   | Quantity used | Delivery time |
|-----|--------------------|--|---------------|---------------|
| 1   | 90 12 05 092 20-00 | shower   | 1             | 10            |
| 2   | 09 23 01 039 90    | sieve  | 1             | 2             |
| 3   | 90 28 22 348 00-00 | pipe   | 1             | 10            |
| 4   | 90 17 11 150 00-00 | holder   | 1             | 10            |
| 5   | 90 28 22 349 00-00 | pipe   | 1             | 10            |
| 6   | 04 17 01 250 00-00 | connection                                       | 1             | 10            |
| 7   | 90 17 33 015 00-00 | handle   | 2             | 10            |
| 8   | 90 14 20 026 00 90 | seal   | 1             | 2             |
| 9   | 12 570 970-00      | Slide unit - Chrome                              | 1             | 10            |
| 10  | 28 322 970-00      | Metal shower hose 1/2" x 3/8" x 1750 mm - Chrome | 1             | 2             |